

# SXT NITRATE Simplex Series

Installation Operation Maintenance Manual

## Installation Operation Maintenance Manual

### Simplex Nitrate Removal With 5600, 2750, 280, 2910SXT Valve Series

#### Models

10 lit	14 lit
20 lit	25 lit
30 lit	40 lit
50 lit	60 lit
75 lit	100 lit
150 lit	250 lit
300 lit	

# SXT NITRATE Simplex Series

## Installation Operation Maintenance Manual

### CONTENTS

NOS.		PAGE
1.0	GENERAL NOTES .....	4
2.0	THE NITRATE REMOVAL PROCESS.....	5
2.1	IN SERVICE.....	5
2.2	REGENERATION.....	5
2.3	THE REGENERATION PROCESS.....	6
2.4	METER CONTROL OF REGENERATION INITIATION.....	6
2.5	TIME CLOCK CONTROL OF REGENERATION INITIATION .....	7
3.0	UNPACKING AND PARTS IDENTIFICATION .....	8
3.1	BASIC PACKAGES.....	8
3.2	UNPACKING NOTES .....	8
3.3	MISSING OR DAMAGED GOODS.....	8
4.0	TEMPORARY STORAGE .....	8
5.0	DESCRIPTION OF PLANT COMPONENTS.....	9
5.1	NITRATE REMOVAL VESSEL AND INTERNALS.....	9
5.2	CONTROL VALVE .....	9
5.3	REGENERATION CONTROLLER AND TRANSFORMER .....	9
5.4	BRINE SYSTEM.....	10
5.5	BLENDING SYSTEM.....	10
6.0	PRE-INSTALLATION .....	11
6.1	MECHANICAL .....	11
6.1.1	Foundation/Drainage.....	11
6.1.2	Operating Space .....	11
6.1.3	Incoming Water.....	11
6.1.4	Pipework .....	12
6.1.5	Water Supply Company Requirements.....	12
6.2	ELECTRICAL .....	12
7.0	ASSEMBLY/INSTALLATION .....	14
7.1	MECHANICAL .....	14
7.1.1	Simplex Models .....	14
7.1.2	Charging the Resin.....	14
7.1.4	Assembling the Control Valve.....	15
7.1.5	Attaching the Control Valve .....	15
7.1.6	Brine System .....	15
7.1.7	Pipework .....	15
7.1.8	Storage tank ball valve.....	16
7.1.9	Drains and overflow connections.....	16
7.1.10	Blending System .....	17
7.2	ELECTRICAL .....	18
7.2.1	Mains Supply .....	18
7.2.2	Transformer.....	18
8.0	COMMISSIONING .....	19
8.1	INTRODUCTION.....	19

# SXT NITRATE Simplex Series

## Installation Operation Maintenance Manual

8.2	CONTROLLER SETTING - Site programming mode.....	19
8.2.1	Setting the Time of Day .....	19
8.2.2	Site programming.....	20
8.3	BRINE SYSTEM.....	21
8.3.1	Salt Tank Filling .....	21
8.4	PRE-SERVICE FLUSH AND REGENERATION .....	22
8.5	Blending System .....	22
9.0	OPERATION .....	24
9.1	NORMAL OPERATION.....	24
9.2	REFILLING WITH SALT .....	24
9.3	MANUAL REGENERATION .....	24
9.4	BY-PASSING THE NITRATE REMOVAL.....	25
9.5	TEMPORARY SHUT-DOWN.....	25
9.6	CHANGES IN INCOMING WATER .....	25
9.7	ROUTINE MONITORING.....	27
10.0	FAULT FINDING AND RECTIFICATION .....	28
10.1	NO FLOW TO SERVICE.....	28
10.2	POOR TREATED WATER QUALITY .....	28
10.3	NO REGENERATION .....	29
10.4	UNSATISFACTORY CAPACITY BETWEEN REGENERATIONS .....	29
11.0	WARRANTY AND SERVICE .....	30
11.1	AFTER SALE WARRANTY .....	30
12.0	DATA .....	31
12.1	PROCESS AND OPERATING DATA.....	31
12.1.1	5600, 2750, 2850, 2910 SXT Series Water Softeners 10-30 litre.....	31
12.1.2	5600, 2750, 2850, 2910 SXT Series Water Softeners 40-75 litre.....	32
12.1.3	5600, 2750, 2850, 2910 SXT Series Water Softeners 100-300 litre.....	33
12.2	ENGINEERING DATA.....	34
12.2.1	10-30 lit 5600, 2750, 2850, 2910 SXT Series Water Softeners.....	34
12.2.2	40-75 lit 5600, 2750, 2850, 2910 SXT Series Water Softeners.....	35
12.2.3	100-300 lit 5600, 2750, 2850, 2910 SXT Series Water Softeners.....	36
13.0	Factory Programming.....	37
13.1	Master Program Settings.....	37
13.2	Master Programming.....	39
13.3	Nitrate Capacity .....	41
13.4	Custom Programming .....	41
13.4.1	<i>Using blender</i> .....	41
13.4.2	Immediate regeneration.....	41
14.0	Drawings .....	42
14.1	Installation Layout.....	42

# SXT NITRATE Simplex Series

## Installation Operation Maintenance Manual

### 1.0 GENERAL NOTES

These instructions cover the 5600, 2750, 2850, 2910 SXT Range of Simplex Water Softeners, which includes models ranging in size from 10-300 litres resin volume.

It is recommended that these instructions are read throughout before commencing any work on the unit, particularly if you have no previous experience of installing and using a water Nitrate Removal.

The installation of a Nitrate Removal is very straightforward, and the only adjustments to be made to the controller program are setting the time of day and water Nitrate as detailed in Section 8.2.2. However we have tried to make these instructions as comprehensive as possible to answer any queries you may have about the functioning of your Nitrate Removal.

This Nitrate Removal will require salt for regeneration. We recommend the use of proprietary 'pellet' or 'tablet' salt.

Drinking softened water has not been shown to be harmful to normal healthy children and adults, but softened water contains a higher level of Sodium than a hard town mains supply. This is of concern to individuals on low Sodium diets or for babies fed with powder formula milk that already contains Sodium. It is therefore recommended that a separate un-softened drinking water supply is left in place or installed on a drinking water faucet. If a cartridge type water filter is installed on the drinking water line, this must be fed with un-softened water.

In the appendix to this manual is the original valve manufacturer's handbook. This is written for American customers and has a number of small differences in the setting up instructions from those used in Europe. In the event of confusion, refer to the data in this manual rather than in the valve manufacturer's handbook!

# SXT NITRATE Simplex Series

## Installation Operation Maintenance Manual

### **2.0 THE NITRATE REMOVAL PROCESS**

Nitrate in water is caused by the presence of dissolved salts of Nitrogen. In order to overcome the problems associated with the use of this water, these salts must be removed. This process is called 'NITRATE REMOVAL'. One means of removing the salts is to exchange them for soluble Sodium salts. This technique is known as 'Ion Exchange NITRATE REMOVAL'.

#### **2.1 IN SERVICE**

In order to treat the water, it is passed through a bed of Ion Exchange resin beads which are contained inside a vertical cylindrical vessel. these beads are made of a synthetic material, and are usually amber or dark brown in colour and between 0.5 and 1.0 mm in diameter.

As the water flows down through the resin, the Nitrogen in the water are progressively exchanged for Sodium, with the result that the water which flows out of the unit contains only Sodium salts. The Nitrogen remain, attached to the resin.

The Ion Exchange resin does not have an unlimited capacity for exchanging Nitrogen, so to keep the exit water soft it is necessary to periodically 'Regenerate' the resin to restore its capacity to soften the water.

#### **2.2 REGENERATION**

The NITRATE REMOVAL process can be reversed if a strong solution of Sodium Chloride (i.e. Common salt dissolved in water -'brine') is passed through the resin.

The high concentration of Sodium allows it to exchange for the Nitrogen held on the resin, and these are then carried away to drain. The resin is left full of Sodium to enable it to soften water again.

# SXT NITRATE Simplex Series

## Installation Operation Maintenance Manual

### 2.3 **THE REGENERATION PROCESS**

The regeneration process consists of four stages:-

**Brine injection/Displacement Rinse** - During the first part of this stage, the concentrated salt -solution is drawn from the salt storage tank, blended with water to reduce the concentration to the correct level, and passed up through the resin. When the required quantity of brine has been drawn in, the water flows alone to push the remaining brine through the resin at the correct rate, and ensure that all the resin sees the right amount of regenerant. The brine/slow rinse stage takes place before backwash in a high efficiency countercurrent regenerating water Nitrate Removal.

**Backwash** - Water flows upwards through the resin bed, and out to a drain. As it does so, it loosens the ion exchange beads, removes any resin 'fines' (i.e. small pieces of broken beads etc.) and cleans off any particles of dirt or pipework corrosion products which may have accumulated during the service cycle.

**Fast Rinse** - This follows the backwash, and entails rinsing away the residual brine and Nitrogen salts from the resin and re-packing the resin bed down. This is done down with water flowing through the resin in the direction of service.

**Salt Tank Refill** - Following the fast rinse, a quantity of water sufficient to dissolve the correct amount of salt for the next regeneration is returned to the salt tank. When this has finished, the unit automatically returns to service.

### 2.4 **METER CONTROL OF REGENERATION INITIATION**

A water meter is installed in the outlet from the Nitrate Removal, to measure the volume of water which passes to service. This meter drives a turbine, the movement of which is measured by a magnetic sensor which sends signals to the regeneration controller. The controller microprocessor uses this information to calculate when the unit should be regenerated. Every night, at 2 am (for example), the volume of water used in the preceding days is compared to the capacity of the Nitrate Removal. The computer then assesses if the resin has enough capacity left to supply the next day's use, and if not, starts the regeneration.

# SXT NITRATE Simplex Series

## Installation Operation Maintenance Manual

### **2.5 TIME CLOCK CONTROL OF REGENERATION INITIATION**

Time clock configuration valves initiate regeneration at a pre-set time after a pre-set number of days. Both the time of day for regeneration and the frequency of regeneration are adjustable.

# SXT NITRATE Simplex Series

## Installation Operation Maintenance Manual

### **3.0 UNPACKING AND PARTS IDENTIFICATION**

#### **3.1 BASIC PACKAGES**

The Nitrate Removal will be delivered in a number of packages which include a glassfibre reinforced pressure vessel, a control valve, a brine tanks, one or more 25 litre bags of resin with one additional part bag, and a funnel to fill the vessel

#### **3.2 UNPACKING NOTES**

The unpacking of the Nitrate Removal is quite straightforward, and there are no 'hidden' items. It is advisable to keep the packages sealed until such time as they are used, to prevent dust or water entry.

Care should be taken in lifting the Nitrate Removal or its parts out of their cartons. It is advisable to lay large cartons on their side and slide out the Nitrate Removal or parts prior to standing them up.

#### **3.3 MISSING OR DAMAGED GOODS**

Immediately on receipt of the goods, it is advisable to check that all items ordered have been received. If you have any doubt that goods have been supplied as requested, please contact your supplier immediately. If any items are missing or damaged, the carrier and your supplier must be notified in writing within 3 days of receipt if a claim is to be made.

### **4.0 TEMPORARY STORAGE**

If installation is not to start immediately after delivery, the equipment should be stored in a clean dry area, where it will not be damaged, or be subjected to temperatures below freezing.

# SXT NITRATE Simplex Series

## Installation Operation Maintenance Manual

### **5.0 DESCRIPTION OF PLANT COMPONENTS**

#### **5.1 NITRATE REMOVAL VESSEL AND INTERNALS**

The pressure vessel which contains the ion exchange resin is made from a fibreglass/epoxy resin outer layer surrounding an inner, seamless shell made from Polyethylene. The vessel has a threaded hole at the top, of 2.5 inch nominal diameter, into which the control valve fits.

All vessels are equipped with a single filter distribution system. This is attached to a central riser tube, which is connected to the control valve, and passes water into and out of the resin bed.

#### **5.2 CONTROL VALVE**

The control valve is mounted on top of the vessel, and directs the water flow in and out of the resin bed during the service and regeneration cycles. The body of the control valve is made from glass reinforced Noryl.

The valve carries out its various functions by rotating a cam that drives a piston through a series of seals and ports. Depending on the position of the piston in the seal stack, the different functions of the valve will take place

#### **5.3 REGENERATION CONTROLLER AND TRANSFORMER**

The regeneration controller is attached to the valve, and is contained in a plastic housing.

The controller is powered by 24v AC electricity, and a separate, wall mounted transformer is connected to the valve to reduce normal mains voltage down from 240v so that all the electrical supply in and around the control valve runs at a safe 24v.

# SXT NITRATE Simplex Series

## Installation Operation Maintenance Manual

### **5.4 BRINE SYSTEM**

The brine system consists of a moulded polyethylene tank into which the brine well and brine pick up are assembled. The tank forms the salt storage container.

The brine pick-up tube is connected to the pipe from the control valve which sucks the brine from the tank. At the bottom of the brine pick-up tube is an air check valve. This serves to prevent air entering the valve when all the brine has been drawn in. Air in the system could cause spurting and 'hammering' at the taps or outlets.

### **5.5 BLENDING SYSTEM**

In some applications, it is beneficial to retain a small proportion of the Nitrate, for instance, to increase the effectiveness of chemical treatments. Under these circumstances, a blending facility is provided in the valve, which allows a set proportion (depending on the raw water Nitrate) of the feed water to bypass the NITRATE REMOVAL resin, before being blended with the softened water prior to the water meter.

# SXT NITRATE Simplex Series

## Installation Operation Maintenance Manual

### 6.0 PRE-INSTALLATION

#### 6.1 MECHANICAL

##### 6.1.1 Foundation/Drainage

The Nitrate Removal will not require any special foundations, provided that a firm, level area which is capable of supporting the working weight is available. (See Engineering Data, Section 12.2)

Unwanted water from the regeneration process must flow to drain, and so an open drain or gully, capable of passing the necessary flow is required (see Process and Operating Data, 12.1, for relevant flows). The total flow of water to drain depends on site conditions, but will be approximately 6 times the resin volume. The drain may be at a level no higher than 500mm above the Nitrate Removal valve.

A second drain is required for the brine tank overflow. This is a safety drain which will only discharge water if there is a malfunction in the control valve. Where possible this should be installed through an outside wall like a cistern overflow, where it will give a visual indication of any failure.

##### 6.1.2 Operating Space

The space occupied by the Nitrate Removal can be found in the Engineering Data (Section 12.2),.

Access will be required to refill the brine tank, and to carry out adjustments or maintenance on the equipment. It is therefore recommended that a minimum of 500mm clearance be allowed in front of the unit for this purpose.

##### 6.1.3 Incoming Water

The raw water to be fed to the Nitrate Removal must comply with the following:-

1. Available at all times at a flow equal to the required service flow or greater, and
2. At a pressure between 1.7 and 5.5 bar
3. Temperature between 0 and 50°C

# SXT NITRATE Simplex Series

## Installation Operation Maintenance Manual

4. Suspended solids less than 1 ppm
5. Iron less than 0.2 ppm, Manganese less than 0.1 ppm, Free Chlorine less than 1 ppm if temperature is less than 15°C, less than 0.3 ppm if temperature higher (up to 30°C)

### 6.1.4 Pipework

Pipework to be connected to the Nitrate Removal should not have an excessive amount of Nitrate scale deposit. Piping that is heavily built up with scale (or Iron deposits) should be replaced.

Make sure that the pipework can be connected to the Nitrate Removal in such a way as to impose no stresses on the control valve, and that it is properly aligned and supported.

A system for the complete by-passing and isolation of the Nitrate Removal should be installed (see Section 7.1.6).

### 6.1.5 Water Supply Company Requirements

It is essential that if the equipment is to be connected directly to a mains water supply, the local bylaws must be adhered to. These cover both plumbing and the prevention of backflow into the mains. If there is any doubt, the local water inspector should be consulted, but in general, the installation of a 'Double check valve assembly' conforming to BS6282 part 2 will be required in the feed pipework to the Nitrate Removal.

If the pressure available from the mains is not adequate it will be necessary to install a booster pump arrangement. Such a system would be covered by additional bylaws, and the water storage tank needed must comply with these.

## 6.2 ***ELECTRICAL***

A continuous supply of 24v, 5 VA is required by the Nitrate Removal. A 240v transformer with an output of 9.6 VA is provided, which should be connected to an uninterrupted mains supply, which is separately 1 Amp fused, and does not have any additional switch.

It is recommended that the transformer be attached to a nearby wall, within 500 mm of the Nitrate Removal in an area free from water spray or excessive heat or condensation.

# SXT NITRATE Simplex Series

## Installation Operation Maintenance Manual

A plug is not provided with this Nitrate Removal since the cable should be connected to fused spur outlet. However if that is not possible then a plug should be fitted to the cable with a 1 amp fuse. The socket used should be un-switched to prevent the Nitrate Removal from being inadvertently turned off.

# SXT NITRATE Simplex Series

## Installation Operation Maintenance Manual

### 7.0 ASSEMBLY/INSTALLATION

#### 7.1 MECHANICAL

Check all the items against the parts list and shipping documents, and ensure you have them all before starting work. In addition to the Nitrate Removal you will require installation materials and basic tools, (i.e., spanners, screwdrivers etc., and PTFE tape)

##### 7.1.1 Simplex Models

###### Assembling Vessel, Riser Tube and Internals

Simplex units are shipped as pre-assembled components to reduce the risk of transit damage. These need to be assembled on site. Open the carton containing the pressure vessel and remove it. Check that the vessel has not been damaged in transit. Pay particular attention to the vessel top hole threads, as this is where the valve will seal. Check that there is no dirt or swarf inside.

###### Riser Tube/Bottom Filter

This comprises a length of pipe (the 'riser tube') to one end of which is glued a moulded screen. The other end is fitted into the bottom of the control valve. To make sure the riser fits properly, and there is no leakage, it will be supplied to the correct length prior to despatch.

##### 7.1.2 Charging the Resin

The ion exchange resin is supplied in 25 litre bags plus a part bag if applicable. All models will be supplied with exactly the right quantity of resin. It is important that only the correct volume of resin is put into the vessel or the system will not function properly. (See **Section 12.1.2** for data)

Place the vessel in its final location - once filled with resin and water they should not be moved. Fill the vessel about 1/5 full with clean water. The riser is 45 mm shorter than the internal height of the vessel so in order to keep it centrally located and prevent resin falling inside the riser, and 'extender/cover' is provided to be slipped over the end of the riser when filling with resin. This must be carefully removed without

# SXT NITRATE Simplex Series

## Installation Operation Maintenance Manual

disturbing the riser prior to fitting the control valve. Carefully open the resin bags and pour the resin into the vessel, using the funnel provided, keeping the riser tube central and upright. Take great care not to spill resin on the floor. If any is spilt, make sure it is swept up immediately, as it is very easy to slip on it. Wash away any loose resin from the threads of the vessel or adapter collar. Remove the riser extender cover and check that the top of the riser is still correctly located

### 7.1.4 Assembling the Control Valve

Carefully remove the control valve from its packing, and check that all parts are present. Fit the top filter/distributor to the valve. This is a 'snap' bayonet fit.

### 7.1.5 Attaching the Control Valve

Carefully fit the control valve on to the vessel, taking care to ensure that the riser tube locates correctly into the valve base through the top distributor, and that the threads are not crossed. Also take care to make sure that the 'O'rings are properly seated and not pinched.

### 7.1.6. Brine System

Move brine tank into position and connect the outer port of the bulk head union to the brine draw connection on the valve using the 3/8" tubing. Make sure that this connection is also tight to stop air leaking in.

If brine draw tubing is adjusted for length during installation, ensure that brass tubing inserts are refitted into tubing end prior to connecting into brine tank and control valve.

### 7.1.7 Pipework

Pipework should be assembled incorporating the features shown in the Installation Diagram, Section 14.1. It is essential that inlet and outlet isolating valves and a by-pass valve are provided, and that the water main is protected by a double check valve where appropriate (see Local Water Bye-laws).

# SXT NITRATE Simplex Series

## Installation Operation Maintenance Manual

In domestic premises it is recommended that a hard water supply is still used for drinking water (see General Notes Section 1.0).

Pipework can be constructed from any normally acceptable material (Copper, Galvanised, Plastic), provided it is properly supported and aligned. Ensure that the pipe is sufficiently large to accommodate the flow of water required, making due allowance for the pressure drop between the Nitrate Removal and the point of discharge of soft water.

***NOTE: IF BRAZED OR SOLDERED FITTINGS ARE TO BE USED, THE PIPEWORK MUST BE DISCONNECTED FROM THE VALVE DURING HEATING AND COOLING. EXCESS HEAT CAN CAUSE PERMANENT DAMAGE TO SOME OF THE VALVE COMPONENTS.***

The inlet and outlet pipework should be connected to the horizontal, rear facing connections on the rear of the valve manifold (1" BSP Female) (see Fig 1 in Section 14.1).

### 7.1.8 Storage tank ball valve

Conventional ball float valves pass water at a slow trickle into storage tanks and cisterns when they are shutting off. Trickle flow is not recommended for satisfactory functioning of a water Nitrate Removal since channelling can occur through the resin bed and the meter may not accurately monitor very low flows. It is therefore recommended that main storage tanks for softened water should have the ball valve replaced with a servo type valve such as a Torbeck or Fluidmaster which permit full flow until they close off. These are inexpensive and are a direct replacement for the more common brass ball float valves.

### 7.1.9 Drains and overflow connections

Connect the overflow fitting on the brine tank to a suitable drain, using flexible or rigid tubing. Make sure that there is a clear gap of approximately 50 mm between the end of the tube and the top of the drain tundish or gully edge.

The drain connection from the valve is a 1/2" hose spigot. Flexible tube should be run from this spigot to a drain capable of taking the maximum flow in regeneration (see Section 12.1), and leaving a similar gap above the drain edge. The drain must not be higher level than the 500mm above the control valve and preferably should have an air break at the same height as the control valve. A standard washing machine upstand is quite suitable for this.

# SXT NITRATE Simplex Series

## Installation Operation Maintenance Manual

### 7.1.10 Blending System

For those applications where it is advantageous to retain some Nitrate in the treated water, a blending system has been fitted. This is controlled by a rotating knob on the left side of the control valve.

# SXT NITRATE Simplex Series

## Installation Operation Maintenance Manual

### 7.2 *ELECTRICAL*

Electrical installation is very straightforward, but should still be carried out by a competent electrician, and must conform to the appropriate standards of safety.

#### 7.2.1 Mains Supply

The mains supply should be through a separate, switched supply, fused and earthed in accordance with Institute of Electrical Engineers Regulations. Current rating should be 1 Amp.

#### 7.2.2 Transformer

A safety transformer is provided to reduce the voltage to 24 Volts to operate the controls.

This should be attached to a convenient wall, within 500mm of the Nitrate Removal. **DO NOT SWITCH ON THE ELECTRICAL SUPPLY AT THIS STAGE** See Fig 3 in Section 14.2

# SXT NITRATE Simplex Series

## Installation Operation Maintenance Manual

### 8.0 COMMISSIONING

#### 8.1 INTRODUCTION



It is recommended that the commissioning of the plant is undertaken by a trained service engineer, who will be able to put the plant into service quickly, and most efficiently. However, if the services of an experienced engineer are not available, following the steps outlined below will result in the system being properly commissioned.

#### 8.2 CONTROLLER SETTING - Site programming mode

All controller settings will require the valve to have a mains supply switched on. The valve must not be regenerating when controller settings are adjusted.

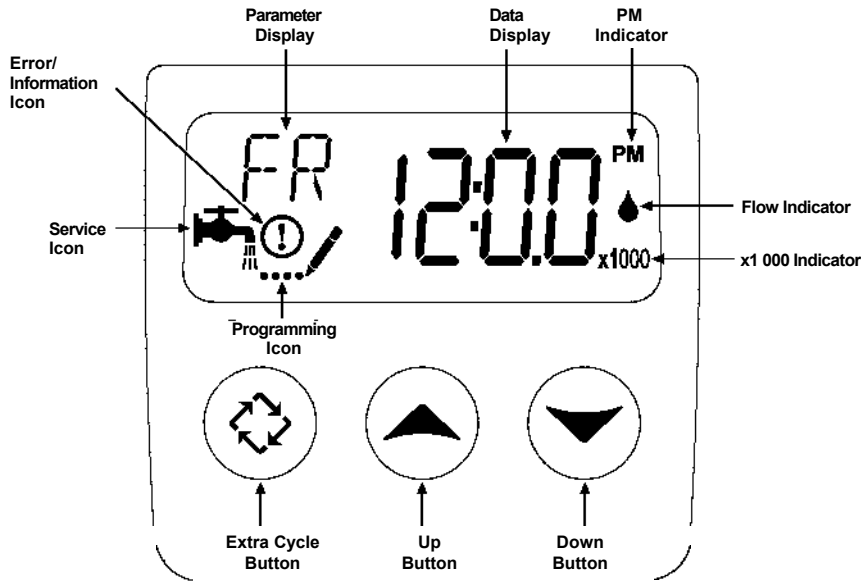

##### 8.2.1 Setting the Time of Day



Meter controlled valves: The display alternates between the time of day on the left and the remaining calculated capacity in litres on the right. Wait until the time of day is displayed and press the up  and down  arrow keys until the correct time of day is displayed.

# SXT NITRATE Simplex Series

## Installation Operation Maintenance Manual

Time clock only valve: The time of day is permanently displayed. Press the up  and down  arrow keys until the correct time of day is displayed.

### 8.2.2 Site programming

- Setting the capacity, time of day of regeneration and regeneration override.

The Nitrate Removal regeneration cycles have been factory programmed. On metered softeners the volume capacity of the resin in litres has also been entered based on a default Nitrate of 20 Degrees Clark and a reserve capacity of 33%. This may need to be altered based on local water Nitrate and reserve required for the occupants of the property (see section 13.1).

The time of day set for regeneration to take place has been entered as 2:00 AM and this may need to be altered depending on site requirements.

On metered softeners, the regeneration override is used to freshen the resin if a regeneration has not taken place for a number of days. On time clock softeners the override is used to set the frequency of regeneration.

To enter the User Menu hold the up and down arrows down together for 5 seconds when the time is not 12:01 and wait for DO to appear on the top left of the screen.

Press the Extra cycle button again to set the day override, prefix DO, default value 7

Press the Extra Cycle button to set the time of regeneration, prefix RT, default value 2:00

Press the Extra Cycle button again to set the feedwater Nitrate in egress French (1 degree = 10 ppm) prefix H

Press the Extra Cycle button again to set the percentage of Reserve Capacity, prefix SF, default value 33.

Press the Extra cycle button again to set the day, prefix

# SXT NITRATE Simplex Series

## Installation Operation Maintenance Manual

### **8.3 BRINE SYSTEM**

#### **8.3.1 Salt Tank Filling**

Place approximately 100 mm depth of water in the bottom of the cabinet. Fill with pellet salt (recommended) until the cabinet it is full or with granular salt until it is 3/4 full.

Overfilling the cabinet with granular salt can result in an overflow of brine. This cannot happen with pellet salt which is why it is recommended.

Under no circumstances use cooking salt or Pure Vacuum Dried (PVD) salt to fill the cabinet as either of these will damage the resin and the internal components of the regeneration valve and brine draw system.

# SXT NITRATE Simplex Series

## Installation Operation Maintenance Manual

### 8.4 **PRE-SERVICE FLUSH AND REGENERATION**

Set the manual isolating valves so that water will by-pass the Nitrate Removal. Turn on the main water supply. Open a soft water tap close by and let the water run for a few minutes to flush out any debris or foreign matter from the pipework system.

#### **Turn on the power supply to the valve.**

Press the extra cycle button for five seconds. The display will then indicate 1-----. Wait for the controller to advance the valve until a time in minutes appears on the right of the display. Press the 'Extra Cycle' button again briefly and the controller will indicate 2-----. Wait for the controller to advance the valve until a time in minutes appears on the right of the display. There will be loud 'click' as the brine valve closes while the valve advances from position 1 to position 2.

Slowly open the mains inlet isolating valve until water starts to flow slowly from the drain line. Air will escape initially through the drain line. When water begins to flow steadily, open the valve fully.

Press the 'Extra Cycle' button three times more to return the valve to service. After each press, wait for a time to appear on the right of the display. There will be loud 'click' as the brine valve closes while the valve advances from position 4 to the home position.

Finally press the 'Extra Cycle' button to initiate a complete regeneration and refill the brine tank to the correct level. Do not advance any of the cycles.

During regeneration the Nitrate Removal will pass hard water to service. The bypass can therefore be closed and the outlet valve opened. When the Nitrate Removal returns to service then soft water will be available.

### 8.5 **Blending System**

The valve may have a built in blending adjustment on the left of the valve body behind and below the control valve powerhead. The blender is factory set to **fully closed**.

Blending is not normally required for domestic applications but is occasionally used for industrial processes where a small amount of Nitrate is used in conjunction with special chemicals.

# SXT NITRATE Simplex Series

## Installation Operation Maintenance Manual

The blender is not calibrated. The blend flow must also be set with the water flowing through the Nitrate Removal at its normal working flow rate.

This is done by trial and error. When the unit is in service, open the blend controller, by turning the knob **clockwise** half a turn. Check the downstream water Nitrate with a test kit and then turn the knob open or closed to adjust the harness to the required level.

A change will then need to be made to the valve programming on metered softeners. See section 13.4 'Custom settings' for information on adjusting the valve program to work correctly with the blender.

# SXT NITRATE Simplex Series

## Installation Operation Maintenance Manual

### 9.0 OPERATION

#### 9.1 *NORMAL OPERATION*

Operation is completely automatic, with regeneration being initiated whenever required by the meter controller.

#### 9.2 *REFILLING WITH SALT*

Since salt is used in the regeneration process, the level of salt in the brine tank will fall after each regeneration. It should not be allowed to fall below 75 mm above the bottom of the cabinet. When the low level is approached (or more often, as a routine) the cabinet should be refilled to the top with pellet salt or 3/4 filled with granular salt.

The approximate capacity of the cabinet for salt is shown in Section 12.1.

#### 9.3 *MANUAL REGENERATION*

There can be occasions during the life of equipment such as softeners when the original design basis is not applicable. For example, after a shutdown period, the demand for soft water may far exceed the design flow rate for a short period. Another possibility is that the Water Service Plc finds it necessary to change to a supply which is much harder than that normally received. It will then be necessary to give the unit an additional regeneration to ensure that soft water continues to be available to service.

This additional regeneration is initiated manually.

Press and hold in the 'Extra Cycle' button for five seconds until the number 1----- appears in the display. Regeneration will proceed automatically immediately.

If the 'Extra Cycle' button is only pressed briefly, the 'Service' indicator will begin to flash immediately and a regeneration will occur at the normal regeneration time (2:00 am set as default).

# SXT NITRATE Simplex Series

## Installation Operation Maintenance Manual

### **9.4 BY-PASSING THE NITRATE REMOVAL**

There may be occasions when it is desirable to by-pass the Nitrate Removal, to allow hard water to go to service, or if the Nitrate Removal is for some reason not performing properly.

To do this, open the by-pass isolating valve and close the Nitrate Removal outlet isolating valve (see Installation Diagram, Fig 3 in Section 14.2). The Nitrate Removal can still be safely regenerated with the valves in this position. If for any reason, it is desired to completely isolate the Nitrate Removal, it will be necessary to close the inlet isolating valve as well.

### **9.5 TEMPORARY SHUT-DOWN**

The Nitrate Removal can be left indefinitely without use. During periods of low or minimal water use, for example during vacation absences, the valve controller will automatically regenerate the resin at the frequency set in the regeneration override.

If the Nitrate Removal needs to be taken out of service for some time for any other reason, it is recommended that one or two simple procedures be undertaken to ensure the return to operation is as smooth as possible.

1. The unit should be left regenerated.
2. The electrical supply should be turned off
3. The inlet and outlet manual isolating valves should be closed.
4. The valve should be drained of water if there is the possibility of the system freezing.

On restart, it will be necessary to reset the 'time of day. It is also recommended that the unit be regenerated again before being put into service.

### **9.6 CHANGES IN INCOMING WATER**

There is a much greater tendency these days for the Water supply Plc to use water from more than one source. It is unlikely that two sources will have similar chemical composition, and so when this happens the raw water being fed to the unit may also change. It is suggested that routine monitoring be undertaken to check whether this is the case (see 9.9). If variation greater than 5% is found, it will be necessary to

# SXT NITRATE Simplex Series

## Installation Operation Maintenance Manual

check whether the settings for regeneration need changing. Resetting is the same as setting.

# SXT NITRATE Simplex Series

## Installation Operation Maintenance Manual

### **9.7 ROUTINE MONITORING**

The following recommendations are made to help the user of the Nitrate Removal confirm that it is performing as required, and to give early warning of possible problems. The operation of the Nitrate Removal is completely automatic, and should not require adjustment (except as above).

#### **Weekly**

Check the treated water Nitrate with a Nitrate test kit.  
Inspect the level of salt in the salt tank and refill if necessary.

#### **Monthly**

Check raw water Nitrate, and record. Compare with original Nitrate and adjust volume capacity setting if required (see Section 13.1).

#### **Annually**

Inspect and clean/replace as necessary the brine injector, piston and the internal seals. This should be performed by a competent engineer familiar with Fleck valves.

# SXT NITRATE Simplex Series

## Installation Operation Maintenance Manual

### 10.0 FAULT FINDING AND RECTIFICATION

Modern water softeners are extremely reliable and unlikely to give any problems if they are installed and operated correctly.

#### 10.1 *NO FLOW TO SERVICE*

Check mains pressure is above 1.7 bar.

Check inlet and outlet isolating valves are open.

Check service outlet valve is open.

Check pressure drop across resin. If excessive, resin may be fouled, or internals blocked. Initiate a regeneration. If this does not free up the resin the Nitrate Removal will need to be inspected and serviced by a competent engineer.

#### 10.2 *POOR TREATED WATER QUALITY*

Check manual by-pass closed.

Check blending valve has not been opened or adjusted.

Check salt level in salt tank. Refill if necessary.

Trickle flow through conventional ball valve in storage tank. Replace with Torbeck or Fluidmaster servo valve.

Check raw water pressure above minimum. If flow is less than minimum, channelling of water can occur in resin. which results in inadequate treatment.

Check injector strainer and injector not blocked (see Appendix for drawings). Clean if necessary.

Check brine pick-up screen not blocked. Clean if necessary.

Check brine line not split. Replace if necessary.

Check raw water Nitrate, and then check if controller setting is correct for this Nitrate (see Section 8)

# SXT NITRATE Simplex Series

## Installation Operation Maintenance Manual

### **10.3 NO REGENERATION**

Check electrical supply, fuses etc. satisfactory.

Check control head motor runs, by initiating a manual regeneration, and listening for drive motor gently 'ticking' as it advances between cycles. Replace if necessary.

Check meter running freely (if fitted) indicated by running a treated water outlet and watching the flow indicator and 'volume remaining' reading on the display count down at the same rate as the water flow.

### **10.4 UNSATISFACTORY CAPACITY BETWEEN REGENERATIONS**

See Section 10.2.

Check condition of resin. It may have become fouled, inhibiting the regeneration process. If fouled, it should be cleaned or replaced.

Check incoming water for presence of Chlorine. If high, the resin may have been degraded.

Check raw water pressure. Too high pressure may mean the brine draw stage of regeneration is not effective

# SXT NITRATE Simplex Series

Installation Operation Maintenance Manual

## **11.0 WARRANTY AND SERVICE**

### ***11.1 AFTER SALE WARRANTY***

Your Nitrate Removal is covered by a parts warranty for a period of one year from installation.

Should you have any problems with your Nitrate Removal or require routine service, please contact your supplier.

# SXT NITRATE Simplex Series

## Installation Operation Maintenance Manual

### 12.0 DATA

#### 12.1 PROCESS AND OPERATING DATA

##### 12.1.1 5600, 2750, 2850, 2910 SXT Series Water Softeners 10-30 litre

MODEL		10 L	14 L	20 L	25 L	30 L
PARAMETER	UNITS					
Max. Service Flow	M3/hr	0.40	0.56	0.8	1.1	1.20
Min Service Flow	M3/hr	0.05	0.07	0.10	0.13	0.15
Volume treated between regens (200 ppm nitrate & sulphate)	M3	2.5	3.5	5.0	6.25	7.5
Salt used per regeneration	kg	2.5	3.5	5.0	6.25	7.5
Resin Volume	litres	10	14	20	25	30
Salt Storage Capacity	kg	80	80	80	80	80
No of Regens Salt stored	-	10	8	5	5	5
Maximum Flow to drain	Lit/min	4.6	4.6	4.6	5.7	7.6

#### IMPORTANT NOTES

Much of the data quoted in the above table is affected by the inlet pressure, and so should be regarded as nominal only.

Total flow to drain will be similarly affected and is therefore not quoted, but will be about 6 times the resin volume.

# SXT NITRATE Simplex Series

## Installation Operation Maintenance Manual

### 12.1.2 5600, 2750, 2850, 2910 SXT Series Water Softeners 40-75 litre

MODEL		40 L	50 L	60 L	75 L
<b>PARAMETER</b>	<b>UNITS</b>				
Max. Service Flow	M3/hr	1.6	2.0	2.4	3.0
Min Service Flow	M3/hr	0.12	0.20	0.24	0.30
Volume treated between regens (200 ppm nitrate & sulphate)	M3	10.0	12.5	15	18.75
Salt used per regeneration	kg	10.0	12.5	15	18.75
Resin Volume	litres	40	50	60	75
Salt Storage Capacity	kg	120	120	160	160
No of Regens Salt stored	-	4	4	6	6
Maximum Flow to drain	Lit/min	7.6	7.6	9.1	13.3

#### IMPORTANT NOTES

Much of the data quoted in the above table is affected by the inlet pressure, and so should be regarded as nominal only.

Total flow to drain will be similarly affected and is therefore not quoted, but will be about 6 times the resin volume.

# SXT NITRATE Simplex Series

## Installation Operation Maintenance Manual

### **12.1.3 5600, 2750, 2850, 2910 SXT Series Water Softeners 100-300 litre**

MODEL		100 L	150 L	250 L	300 L
<b>PARAMETER</b>	<b>UNITS</b>				
Max. Service Flow	M3/hr	4.00	5.6	10	12
Min Service Flow	M3/hr	0.5	0.75	1.25	1.4
Volume treated between regens (200 ppm nitrate & sulphate)	M3	25	37.5	62.5	75
Salt used per regeneration	kg	25	37.5	62.5	75
Resin Volume	litres	100	150	250	300
Salt Storage Capacity	kg	300	400	500	750
No of Regens Salt stored	-	4	4	2	3
Maximum Flow to drain	Lit/min	19	26.5	39.8	56.8

#### **IMPORTANT NOTES**

Much of the data quoted in the above table is affected by the inlet pressure, and so should be regarded as nominal only.

Total flow to drain will be similarly affected and is therefore not quoted, but will be about 6 times the resin volume.

# SXT NITRATE Simplex Series

## Installation Operation Maintenance Manual

### 12.2 ENGINEERING DATA

#### 12.2.1 10-30 lit 5600, 2750, 2850, 2910 SXT Series Water Softeners

MODEL		10 L	14 L	20 L	25 L	30 L
PARAMETER	UNITS					
Diameter of vessel/valve	mm	220	220	220	250	270
Height to top of valve	mm	640	800	1105	1105	1105
Diameter of brine tank	mm	460	460	460	460	460
Height of brine tank	mm	630	630	630	630	630
Inlet Conn.	ins BSPF	1.0	1.0	1.0	1.0	1.0
Outlet Conn.	ins BSPF	1.0	1.0	1.0	1.0	1.0
Drain Conn.	ins	1/2	1/2	1/2	1/2	1/2
Brine Tank Overflow Conn.	ins	3/4	3/4	3/4	3/4	3/4
Delivered Wt.	Kg.	16	22	34	39	44
Working Wt. (approx)	Kg	46	57	94	99	104
Maximum Flow to drain	Lit/min	4.6	4.6	4.6	5.7	7.6
Electrical Power	v	240	240	240	240	240
	Hz	50	50	50	50	50
	V/A	1.2	1.2	1.2	1.2	1.2

MAXIMUM OPERATING PRESSURE 5.5 Bar MINIMUM OPERATING PRESSURE 1.7 Bar MAXIMUM OPERATING TEMPERATURE 50.0C  
 HEADROOM - Allow 100 mm greater than overall height.

# SXT NITRATE Simplex Series

## Installation Operation Maintenance Manual

### 12.2.2 40-75 lit 5600, 2750, 2850, 2910 SXT Series Water Softeners

MODEL		40 L	50 L	60 L	75 L
PARAMETER	UNITS				
Width of vessel/valve	mm	270	270	315	330
Height to top of valve	mm	1320	1580	1420	1570
Diameter of brine tank	mm	465	465	555	555
Height of brine tank	mm	800	800	980	980
Inlet Conn.	ins BSPF	1.0	1.0	1.0	1.0
Outlet Conn.	ins BSPF	1.0	1.0	1.0	1.0
Drain Conn.	ins	1/2	1/2	1/2	1/2
Brine Tank Overflow Conn.	ins	1/2	1/2	1/2	1/2
Delivered Wt.	Kg.	55	65	75	90
Working Wt. (approx)	Kg.	170	180	300	320
Maximum Flow to drain	Lit/min	7.6	7.6	9.1	13.3
Electrical Power	v	240	240	240	240
	Hz	50	50	50	50
	V/A	1.2	1.2	1.2	1.2

MAXIMUM OPERATING PRESSURE 5.5 Bar MINIMUM OPERATING PRESSURE 1.7 Bar MAXIMUM OPERATING TEMPERATURE 50.0C  
 HEADROOM - Allow 100 mm greater than overall height.

# SXT NITRATE Simplex Series

## Installation Operation Maintenance Manual

### 12.2.3 100-300 lit 5600, 2750, 2850, 2910 SXT Series Water Softeners

MODEL		100L	150L	250L	300L
PARAMETER	UNITS				
Width of vessel/valve	mm	356	407	534	610
Height to top of valve	mm	1984	1988	2038	2335
Diameter of brine tank	mm	950	900	1250	1330
Height of brine tank	mm	700	840	960	1050
Inlet Conn.	ins BSPF	1.0	1.0	1.1/2	2.0
Outlet Conn.	ins BSPF	1.0	1.0	1.1/2	2.0
Drain Conn.	ins	1/2	1/2	1	1
Brine Tank Overflow Conn.	ins	1/2	1/2	1/2	1/2
Delivered Wt.	Kg.	100	170	340	400
Working Wt. (approx)	Kg.	200	300	600	700
Maximum Flow to drain	Lit/min	19	26.5	37.85	57
Electrical Power	v	240			
	Hz	50			
	V/A	120			

MAXIMUM OPERATING PRESSURE 5.5 Bar MINIMUM OPERATING  
PRESSURE 1.7 Bar MAXIMUM OPERATING TEMPERATURE 50.0C  
HEADROOM - Allow 100 mm greater than overall height.

# SXT NITRATE Simplex Series

## Installation Operation Maintenance Manual

### 13.0 Factory Programming

#### 13.1 Master Program Settings

##### Master Program set up summary

Details applicable to each valve or programming type are in the columns 'T/C' (Timeclock) and 'DEL' (Delayed regeneration). Regeneration cycle data applicable to each resin volume is shown in the resin volume columns. The treated water capacity is entered as 66% of the resin capacity at 300 ppm giving a 33% reserve.

To adjust any of these settings see the following section, 13.2

Parameter description	Disp	Value	Res Vol	10	14	20	25	30	40	50	75
Display Format	DF	Ltr									
Valve Type	VT	dF1b									
Control Type	CT	Fd									
Number of Tanks	NT	1									
Unit capacity	C	see across	⇒	50	70	100	125	150	200	250	375
Feedwater Nitrate	H	20									
Reserve Selection	RS	SF									
Safety Factor	SF	30									
Day Override	DO	7									
Regeneration Time	RT	2:00									
BackWash	BW	See across	⇒	4	4	4	4	6	6	6	6
Brine Draw/Slow Rinse	BD	See across	⇒	40	40	40	40	60	60	60	60
Fast Rinse	RR	See across	⇒	4	4	4	4	6	6	6	6
Brine Refill *	BF	See across	⇒	6	8	10	14	16	12	14	22
Flow meter type	FM	t.0.7									
Exit to time of day											

# SXT NITRATE Simplex Series

## Installation Operation Maintenance Manual

Parameter description	Disp	Value	Res Vol	100	150	250	300
Display Format	DF	Ltr					
Valve Type	VT	dF1b					
Control Type	CT	Fd					
Number of Tanks	NT	1					
Unit capacity	C	see across	⇒	500	750	1250	1500
Feedwater Nitrate	H	20					
Reserve Selection	RS	SF					
Safety Factor	SF	30					
Day Override	DO	7					
Regeneration Time	RT	2:00					
BackWash	BW	See across	⇒	6	8	10	10
Brine Draw/Slow Rinse	BD	See across	⇒	60	80	100	60
Fast Rinse	RR	See across	⇒	6	8	10	10
Brine Refill *	BF	See across	⇒	14	20	18	16
Flow meter type	FM	t.0.7					
Exit to time of day							



# SXT NITRATE Simplex Series

## Installation Operation Maintenance Manual

### 13.2 Master Programming

This section is for information only. The valve is pre-programmed and will not need adjustments made to the Master Level Program unless custom settings are required.

Set the time of day display to 12:01

Press and hold the press the up  and down  arrow keys together for 5 seconds.

A 'DF' will appear in the left of the display. The letter on the right sets the display format GAL-Gallons, Ltr- Litres or Cu Cubic

Press Extra Cycle button again to set valve type which is prefixed 'VT'

This should be set to dF1b.

Press Extra Cycle button again to set control type.

- Fd – Meter delay
- FI – Meter Immediate
- Tc – Time Clock
- dAy – Day of week

Press the Extra Cycle button again to set the number of tanks, 1, prefix NT

Press the Extra Cycle button again to set the capacity as per the chart, prefix C

Press the Extra Cycle button again to set the feedwater Nitrate in degrees French (1 degree = 10 ppm) prefix H

Press the Extra Cycle button again to set the Reserve Capacity, prefix SF to indicate percentage reserve

Press the Extra Cycle button again to set the percentage of Reserve Capacity, prefix SF, default value 33.

Press the Extra cycle button again to set the day override, prefix DO, default value 7

Press the Extra Cycle Button again to set the time of day of regeneration. This has the same function as the regeneration time setting in the Site Setting program - see section 8.2.2. The default is set to 2:00 am.

.

# SXT NITRATE Simplex Series

## Installation Operation Maintenance Manual

Press the Extra Cycle button again to set regeneration cycle 1 - brine draw and slow rinse. Set this as shown in the table above.

Press the Extra Cycle button again to set regeneration cycle 2 - backwash. Set this as shown in the table above.

Press the Extra Cycle button again to set regeneration cycle 3 - fast rinse. Set this as shown in the table above.

Press the Extra Cycle button again to set regeneration cycle 4 - brine refill. Set this as shown in the table above.

Press the Extra Cycle button again to set the flow meter size on metered softeners. With metric settings the display should read t.0.7

Press the Extra Cycle button again to exit the Master Programming mode

# SXT NITRATE Simplex Series

## Installation Operation Maintenance Manual

### **13.3 Nitrate Capacity**

When sizing a nitrate removal unit the capacity is set of a combine nitrate and sulphate figure.

### **13.4 Custom Programming**

There are two variations on the settings that may be required. Both need adjustments to be made through the Master Programming Mode.

#### **13.4.1 Using blender.**

If the blender fitted to the valve is to be used, the valve capacity needs to be adjusted. This means that the valve will still be able to calculate when the resin should be regenerated without wasting salt.

You will first need to adjust the blender and check the Nitrate of the blended water on site during normal service flow.

Next, calculate the percentage or proportion of the blended water when compared with the raw water. If, for example, the Nitrate of the blended water is 60 ppm, and the raw water is 300 ppm, the proportion of blended water is  $60/300 = 1/5$ , or 20%. The 'capacity' of the Nitrate Removal can then be increased by 20%, saving salt.

#### **13.4.2 Immediate regeneration.**

The valve is factory programmed for delayed regeneration which means that it will check whether it has zeroed out at the pre-programmed regeneration time (factory set to 2:00 AM).

However the valve can also be set for 'immediate' regeneration when it will regenerate as soon as the water meter zeroes out at any time of the day. The setting is made in step 2 of the Master Programming mode when the setting should be changed to 7--2. (see section 13.2)

No reserve needs to be allows for the system capacity when the Nitrate Removal is programmed for immediate regeneration.

Please note, that there will then be no 'regeneration time of day' option presented during the Master or Site Programming modes when immediate regeneration is selected.

# SXT NITRATE Simplex Series

## Installation Operation Maintenance Manual

### 14.0 Drawings

#### 14.1 Installation Layout

Fig 1 General Installation Layout 5600, 2750, 2850, 2910 SXT Simplex Softeners

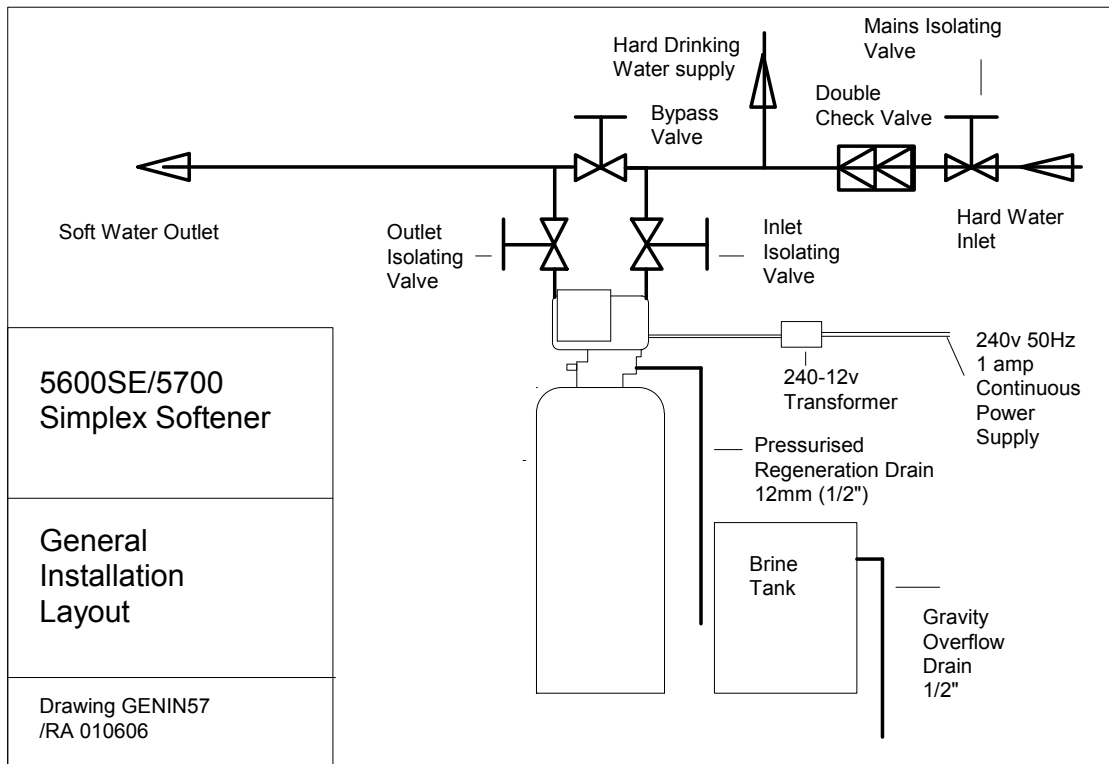

# SXT NITRATE Simplex Series

Installation Operation Maintenance Manual

## Manufacturer's Declaration of Conformity

We the undersigned

**EURAQUA UK, HITCHIN, ENGLAND**

Certify that the product

---

***type: SIMPLEX WATER NITRATE REMOVAL WITH FLECK 5600, 2750, 2850,  
2910 SXT  
24 VOLT AC VALVE***

---

*has been designed and manufactured in accordance with the  
specifications of the following:*

### Directive

Machinery Directive 89/392/EEC  
Low Voltage Directive 73/23/EEC  
EMC-Directive 89/336/EEC

### Standard

EN 292-1, EN 292-2  
EN 60 335-1  
EN 55 014

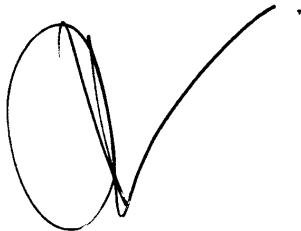

RT Adam  
Director

**Hitchin, England 01/01/01**  
*Issue place & date*